



Optimal Solutions for the Future

DVM II series



**High Precision Die
& Mold Vertical
Machining Center**

DVM II series

DVM 500 II
DVM 650 II

ver. EN 160803 SU

DVM 500 II / DVM 650 II

The DVM II series seeks to make the spindle harder and last longer than the preceding DVM II series by opting for a static pressure spindle. The door width has been expanded to 2-door to make product installation more convenient. Furthermore, the quality of machining has been improved by standardizing the nut cooling ball screws of each spindle and the heat-shielding insulation in the columns in order to minimize heat displacement.

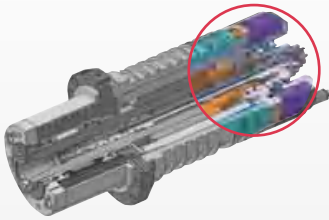

Greater strength and longer service life of spindle Upgrade

Uses a static pressure spindle to maintain strength in the lowspeed section and increase service life in the high-speed section



Increased convenience Upgrade

Increases width of door by shifting to 2-door, making installation of product more convenient



Increases capacity of lubricating unit to reduce frequency of replacing lubricant

Previous model DVM 500 II / 650 II
2.0 L ▶ 4.3 L

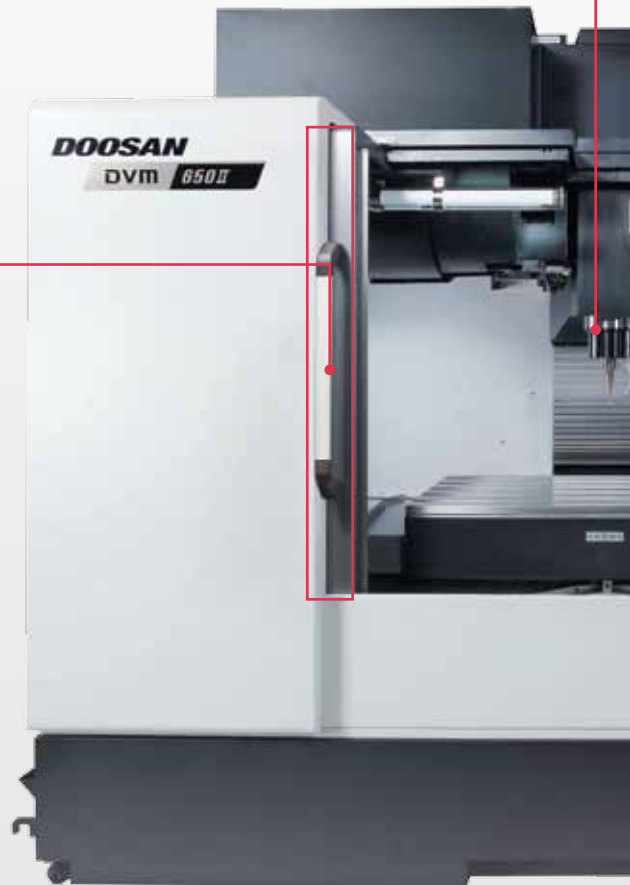

High Precision Die & Mold Vertical Machining Center

Developed to provide high precision and high performance for die & mold machining



Improvement of machining quality Upgrade

Using nut cooling ball screws on every spindle (X, Y, and Z) reduces heat displacement by **up to 47%** compared with previous models

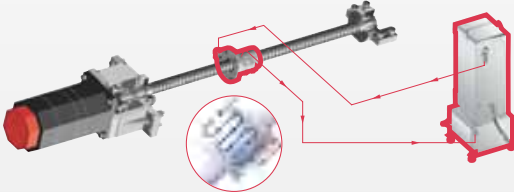

Applying heat-shielding insulation minimizes thermal deformation of structure

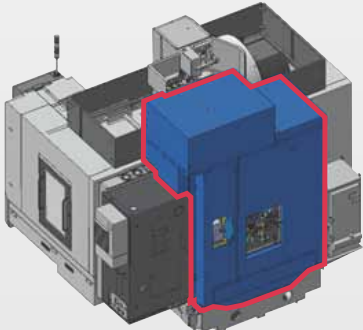

Die & Mold Machining Solution

The DVM II Series performs precision machining due to the high level of rigidity built into the machine structure at the design stage. In addition, special functions such as spindle thermal displacement compensation, high speed / precision contour control and optimised federate control contribute to the highest level of workpiece accuracy and quality.

DVM 500 II / DVM 650 II

Die & Mold solution

Spindle power-torque diagram



High Rigidity Design

To minimize the bearing and motor heat a high-precision oil cooler controls the temperature to 0.1 degree.

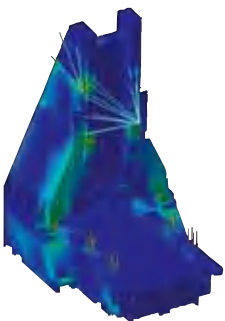

Static rigidity

The high rigidity structure of DVM II has raised the static rigidity up by 30% more than previous model with no weak point through FEM* analysis.

* FEM : Finite Element Method

Dynamic rigidity

Improving the frequency response and the damping ability of vibration makes it possible to increase the eigenfrequency 35% up on the previous model.

High strength feed drive

Roller guide applied



Rigid coupling



Ball screw nut cooling

Feed axis thermal displacement largely reduced Feed drive strength maintained in stable condition

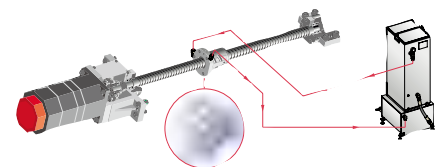





High Speed / Precision Contour Control

* DSQ : Doosan Super Quality

Smooths the movement of the machine, improving surface roughness and profile accuracy of corners and edges.

- DSQ1 (Look ahead 200 block + Machining condition selection function) 
- DSQ2 (DSQ1 + Data server [1GB]) 
- DSQ3 (DSQ2 + High Speed Processing) 



Verification sample VASE



with DSQ without DSQ

Machining condition selection function

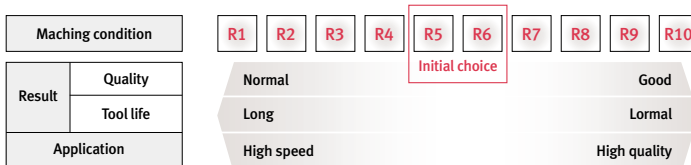

It is possible to change machining condition in 10 steps by using R code at the program.

- Improving productivity (high speed at rough machining, high precision at finish cutting)

NC parameter such as maximum feed and deceleration time can be set automatically

Thermal Displacement Compensation

Thermal displacement of the spindle is minimized, so processing accuracy can be maintained for even long periods of use. Automatic tool measurement device and High-performance oil-cooler as standard. 

Spindle static displacement compensation

To compensation displacement of tool by by thermal deformation of spindle at high RPM.

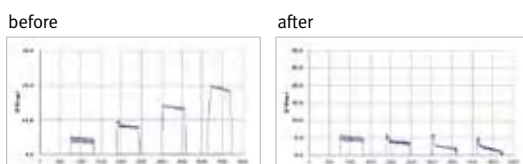

Thermal displacement compensation

Thermal displacement compensation is achieved with 5 algorithm including smoothing function.

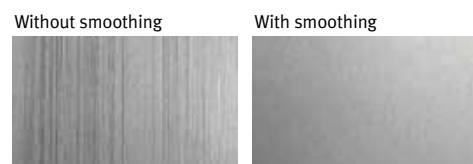

Built-in Spindle

High speed spindle achieves stable accuracy and high precision machining even during long periods of operation.

This optimises productivity and workpiece accuracy.

DVM 500 II / DVM 650 II

High-Quality Spindle with Low Heat Generation, Low Vibration and High Rigidity

Spindle vibration is minimized by shortening its length and optimization bearing pre-tension

Spindle length

- Improving productivity (high speed at rough machining, high precision at finish machining)

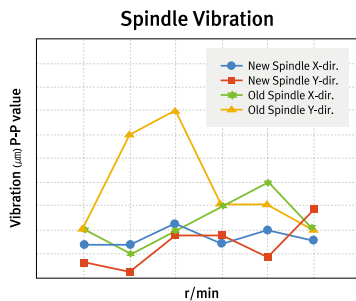

Low vibration spindle

- High precision balance and short spindle length by 40% than the previous model

0.1 degree spindle head cooling system

To minimize the bearing and motor heat a high-precision oil cooler controls the temperature to 0.1 degree.

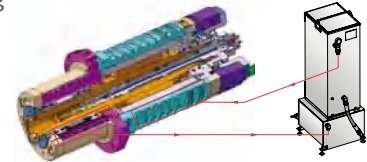

Oil air lubrication

An optimal amount lubrication oil is applied by high pressure air to the bearings.

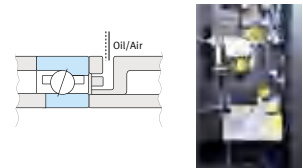

Spindle Power - Torque Diagram

High speed / precision built-in spindle

Spindle motor

22 kW (29.5 Hp)

Max. speed

20000 r/min

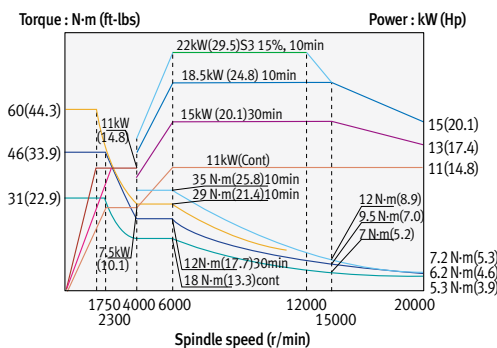

2-Face locking tool system

BT40 tool & 2-Face locking tool system (BIG PLUS) applied as standard

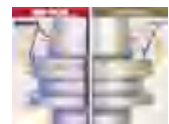

Automatic tool measurement

Automatic tool measurement (TS27R)



Air blower

Dry cutting and MQL easy applied.

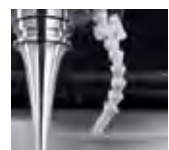



High Precision

High precision spindle run-out and highly rigid axis traverse system

∅ 0.2 mm micro feed needle machining

Needle machining is achieved by minimum spindle run-out and low vibration micro feed using a highly rigid axis traverse system.

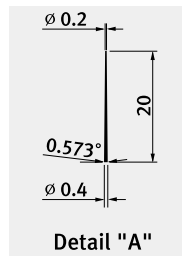

High precision micro feed / surface roughness

Work Sample

Variation of offset value of workpiece height is less than

0.5µm (actual result)

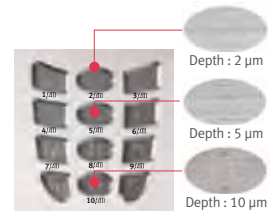

High Productivity

The comparison of cycle time (actual result)

A competitor's machine

44hr 30min



DVM 500 II

34hr 30min

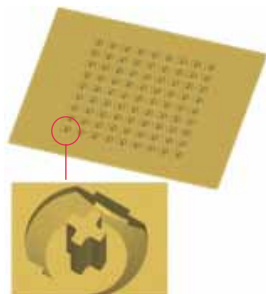

VASE (Verification sample) cycle time

A competitor's machine

22min 44s



DVM 500 II

21min 32s

Interpolation of XYZ-axis



Chip Disposal

Management of chips from the viewpoint of productivity improvement and environmental countermeasure is important. DVM II series offer a variety of chip control equipment to provide enhanced accuracy and better chip removal capabilities.

Easy chip disposal structure

The completely enclosed DVM II series guarantee the confinement of chips and coolant to the inside of the machining area. Chips fall into the removable forward mounted chip pan for easy disposal.

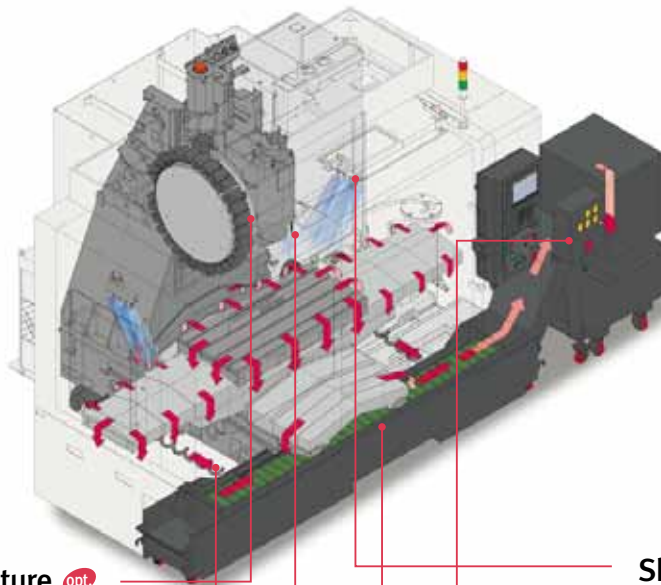

Oil/Water separation structure opt.

Middle pressure 1.96 Mpa (284.2 psi) [20 bar]
High pressure 6.86 Mpa (994.7 psi) [70 bar]



Screw conveyor



Flood coolant pump



Shower coolant opt.

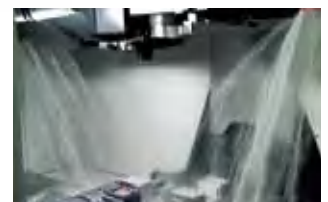

Chip conveyor opt.

Hinge type



Scraper type



Drum filter type



Large capacity coolant tank with chip pan and box filter

Easy to discard chips piled up



Coolant tank capacity 380L



Improved Maintainability

Maintainability is one of the crucial criteria that Doosan placed at the forefront of machine development. Large openings in the machine paneling facilitate access to the underlying maintenance units like lubricant oil tank and pneumatic fittings.

Operating console



1. Swivelling Operating Console
An easy-to-use operation panel which can swivel from 0-90°
2. ATC operating button is arranged to Main Panel



This can give much easier operation and maintenance for ATC.

3. Portable MPG



Portable MPG makes a workpiece setting easier for the operator.

2-Door

Top cover can be opened to provide easy access for loading heavy workpieces to the center of the table.



Brighter working area

Fluorescent lamps for safety and clear view of the working area.



Seperates cutting fluid from wasted oil in coolant tank std.

It prolongs the use of cutting fluid and also enhances productivity. As an optional feature, oil skimmer can be attached for better efficiency.

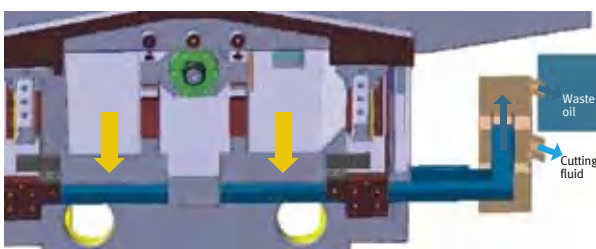

Air port std.

Air port is provided as a standard feature. (Air gun : opt.)

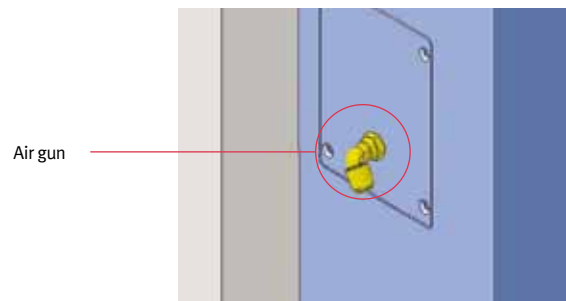

Easy operation package

These Doosan software packages have been customised to provide fast and easy operation for tooling, workpiece and program set up. These features minimise the lost time caused by process setup and maximises the machine's productivity.



std.

Fanuc 31i

10.4" color TFT LCD

Part Program Storage 640m

Ethernet Function (Embedded)

Programming

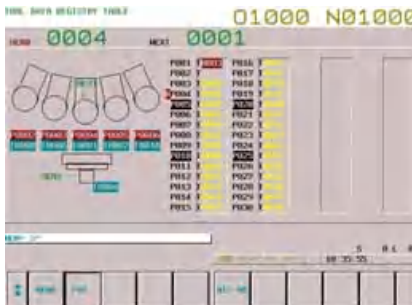

Tool data registry table

Operator can edit & check the tool number of magazine pot.

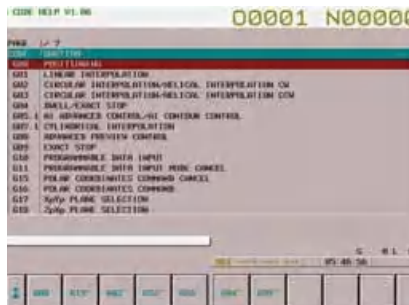

G Code list

Operator can check the meaning of each G-code.

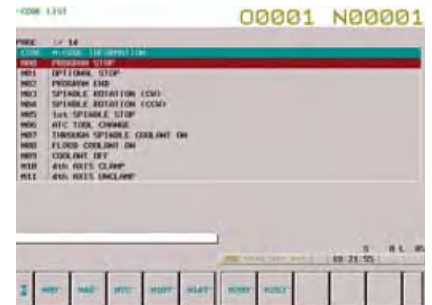

M Code list

Operator can check the meaning of each M-code.

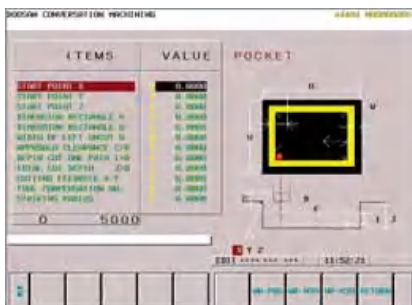

Pattern cycle

It is easy to make pattern cycle program by this function.

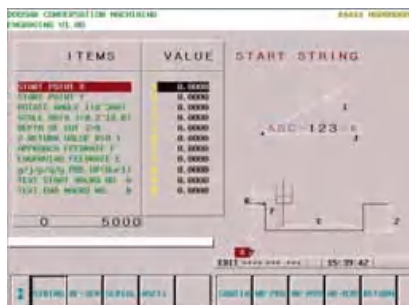

ENGRAVING opt.

It makes number and letter engraving programming easier.



Calculator

Operator can easily calculate numerical formulas in relation to arc and hole patterns.

Operation / Maintenance

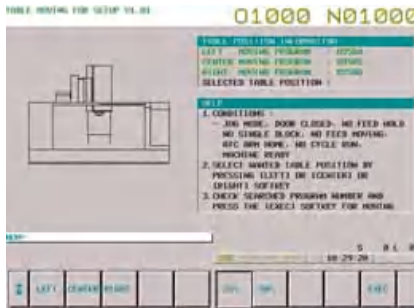

Table moving for setup
It is easy to move the table to 3 positions along the X-axis.



ATC recovery help
It makes operator recovery of the ATC from alarm status easier.



Sensor status monitor
Solenoid valve and Sensor status can be checked without the electric diagram.



Easy NC parameter help
Operator can check some useful parameters for easy operation.



Operation rate
Working and operation time by each operator can be managed.



Tool load monitor opt.
The axis and spindle load in cutting are monitored which minimises damage to the tool.

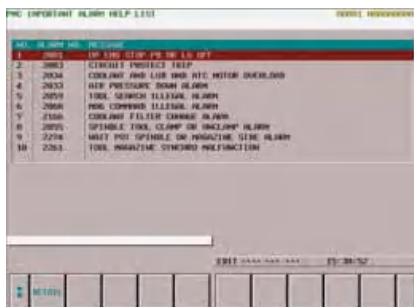

Alarm guidance
Recovery method for important alarms is displayed on the screen.



RENISHAW GUI (Tool measure std.)
(Work measure opt.)
Tool & work measure system of Renishaw is operated on conversational screen.

Optional Equipment

Improves machine productivity.

Interface for additional equipment

- Recommended Rotary Table : \varnothing 250 (DVM 500 II), \varnothing 320 (DVM 650 II)

- Connection example of additional 4 axis interface
- Connection example of fixture interface

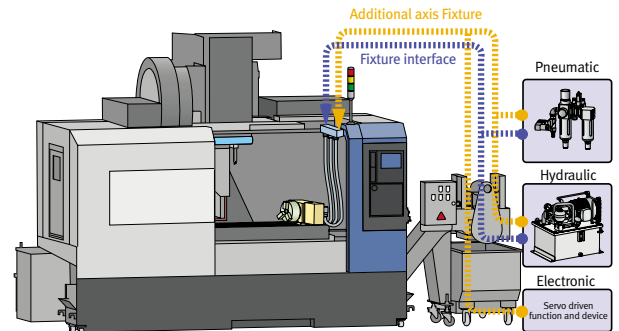

Coolant chiller opt.

The coolant chiller lowers coolant temperature, helping to cool both the workpiece and tool during the machining operation.

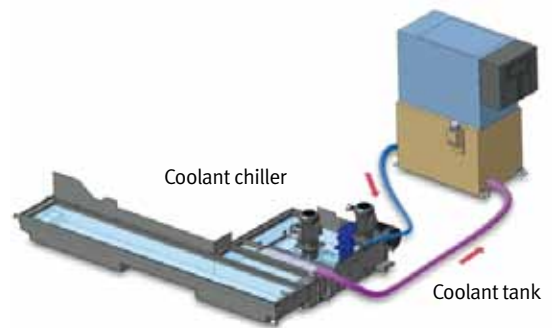

Through spindle coolant



Automatic front door



MQL (Minimum quantity lubrication)



Oil skimmer



Coolant gun



Automatic tool measurement

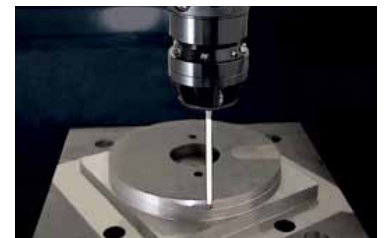

Additional axis interface



Rear chip conveyor

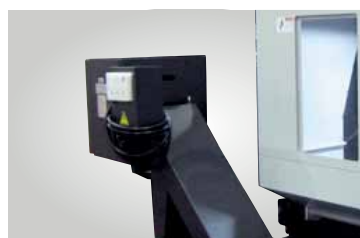

Automatic tool breakage detection



External Dimensions & Table Dimensions

DVM 500 II

Top view

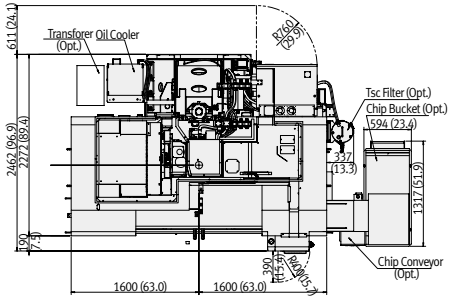

Front view

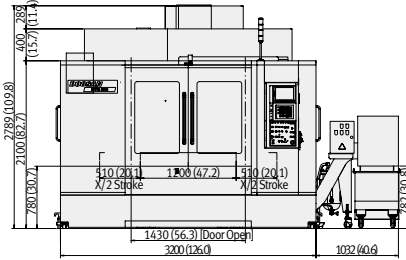

Side view

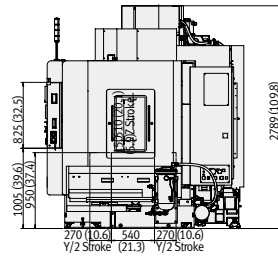

Table

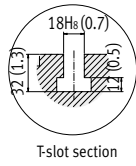
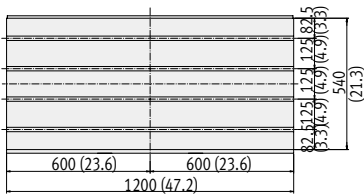

Tool shank (MAS 403 BT 40)

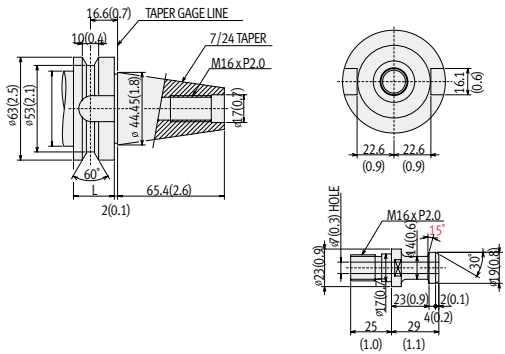

DVM 650 II

Top view

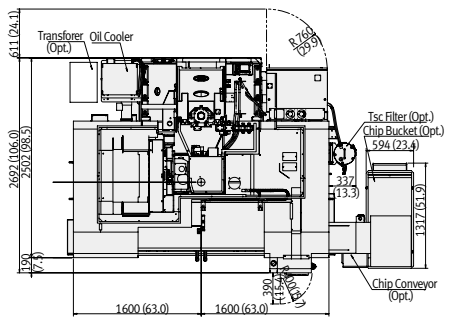

Front view

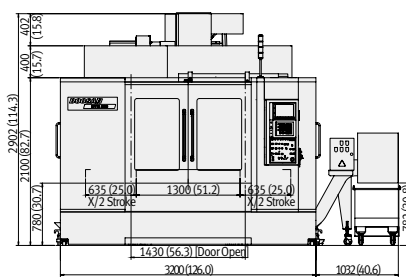

Side view

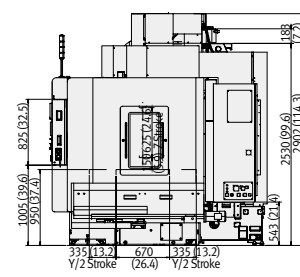

Table

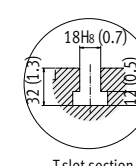
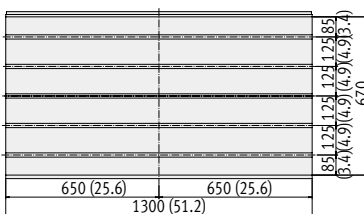

Machine Specifications

	Description	Unit	DVM 500 II	DVM 650 II
Travels	X-axis	mm (inch)	1020 (40.2)	1270 (50.0)
	Y-axis	mm (inch)	540 (21.3)	670 (26.4)
	Z-axis	mm (inch)	510 (20.1)	625 (24.6)
	Distance from spindle nose to table top	mm (inch)	150 - 660 (5.9 - 26.0)	150 - 775 (5.9 - 30.5)
Feedrate	Rapid traverse rate (X / Y / Z)	m/min (ipm)	30 / 30 / 30 (1181.1 / 1181.1 / 1181.1)	
	Cutting feedrate	mm/min (ipm)	1~15000 (1~590.6)	1~24000
Table	Table size	mm (inch)	1200 x 540 (47.2 x 21.3)	1300 x 670 (51.2 x 26.4)
	Table loading capacity	kg (lb)	800 (1763.7)	1000 (2204.6)
Spindle	Max. spindle speed	r/min	20000	
	Spindle taper		ISO #40, 7/24 Taper	
	Max. Spindle torque	N-m (ft-lbs)	60 (44.3)	
Automatic Tool Changer	Type of tool shank		MAS403 BT40	
	Tool storage capacity	ea	30 {40}	
	Max. tool diameter	mm (inch)	80 / 125 {76 / 125} (3.2 / 4.9 {3.0 / 4.9})	
	Max. tool length	mm (inch)	300 (11.8)	
	Max. tool weight	kg (lb)	8 (17.6)	
	Method of tool selection		Memory random	
	Tool change time (tool-to-tool)	s	1.3	
	Tool change time (chip-to-chip)	s	3.7	
Motors	Spindle motor (30 min.)	kW (Hp)	11 / 15 / 22 (14.8 / 20.1 / 29.5)	
Power Source	Electric power supply (Rated Capacity)	kVA	44.6	
Tank Capacity	Coolant tank capacity	L (gal)	380 (100.4)	
	Lubrication tank capacity	L (gal)	4.3 (1.1)	
Machine Dimensions	Height	mm (inch)	2789 (109.8)	2905 (114.4)
	Length X Width	mm (inch)	2462 x 3350 (96.9 x 131.9)	2692 x 3350 (106.0 x 131.9)
	Weight	kg (lb)	6500 (14329.8)	8500 (18739.0)
NC System	CNC Unit		Fanuc 31i	

{ } : Option

Standard feature

- Assembly & operation tools
- Air blower
- Automatic power off
- Automatic tool measurement (TS27R)
- Coolant tank & chip pan
- DSQ1
(look ahead 200 block + machining condition selection function)
- Portable MPG
- Screw conveyor
- Signal tower (red, yellow, green)
- Spindle head cooling system
- Splash guard

Optional feature

- 4th / 5th axis preparation
- Air dryer
- Chip conveyor & chip bucket
- Coolant Chiller
- DSQ2 (DSQ1 + Data server [1GB])
- DSQ3 (DSQ2 + High Speed Processing)
- Mist collector
- Test bar
- Through spindle coolant

- The specifications and information above-mentioned may be changed without prior notice.
- For more details, please contact Doosan

NC Unit Specifications

Fanuc 31i

AXES CONTROL

- Controlled axes	3 (X,Y,Z)
- Simultaneously controllable axes	
	Positioning(G00)/Linear interpolation(G01) : 3 axes
	Circular interpolation(G02, G03) : 2 axes
- Backlash compensation	
- Emergency stop / overtravelnsation	
- Follow up	
- Least command increment :	0.001mm / 0.0001"
- Least input increment :	0.001mm / 0.0001"
- Machine lock	all axes / Z axis
- Mirror image	
	Reverse axis movement (setting screen and M - function)
- Stored pitch error compensation	
	Pitch error offset compensation for each axis
- Stored stroke check 1	Overtravel controlled by software

INTERPOLATION & FEED FUNCTION

- 2nd reference point return	G30
- Circular interpolation	G02, G03
- Dwell	G04
- Exact stop check	G09, G61(mode)
- Feed per minute	mm / min
- Feedrate override (10% increments)	0 - 200 %
- Jog override (10% increments)	0 - 200 %
- Linear interpolation	G01
- Manual handle feed 1 unit	
- Manual handle feed 2/3 unit	
- Manual handle feedrate	0.1/0.01/0.001mm
- Override cancel	M48 / M49
- Positioning	G00
- Rapid traverse override	F0 (fine feed), 25 / 50 / 100 %
- Reference point return	G27, G28, G29
- Skip function	G31
- Helical interpolation	
- DSQ1(AICC II + Machine condition selection function)	200 block preview
- Thread cutting, synchronous cutting	
- Program restart	
- Automatic corner deceleration (Specify AI Contour control II)	
- Feedrate clamp by circular acceleration	
- Linear ACC/DEC before interpolation (Specify AI Contour control II)	
- Linear ACC/DEC after interpolation	
- Control axis detach	
- Rapid traverse bell-shaped acceleration/deceleration	
- Smooth backlash compensation	

SPINDLE & M-CODE FUNCTION

- M- code function	M 3 digits
- Spindle orientation	
- Spindle serial output	
- Spindle speed command	S5 digits
- Spindle speed override (10% increments)	50 - 150 %
- Spindle output switching	
- Retraction for rigid tapping	
- Rigid tapping	G84, G74

FEED FUNCTION

- Tool nose radius compensation	G40, G41, G42
- Number of tool offsets	64 ea
- Tool length compensation	G43, G44, G49
- Tool number command	T2 digits
- Tool life management	
	Geometry / Wear and Length / Radius offset memory
- Tool offset memory C	
- Tool length measurement	

PROGRAMMING & EDITING FUNCTION

- Absolute / Incremental programming	G90 / G91
- Auto. Coordinate system setting	
- Background editing	
- Canned cycle	G73, G74, G76, G80 - G89, G99
- Circular interpolation by radius programming	
- Custom macro B	
- Custom size 512Kb	
- Decimal point input	
- I / O interface	RS - 232C
- Inch / metric conversion	G20 / G21
- Label skip	
- Local / Machine coordinate system	G52 / G53
- Maximum commandable value	±99999.999mm (±9999.9999 inch)
- No. of Registered programs	500 ea
- Optional stop	M01

- Part program storage	640 m
- Program number	O4-digits
- Program protect	
- Program stop / end	M00 / M02,M30
- Programmable data input	
	Tool offset and work offset are entered by G10, G11
- Sub program	Up to 4 nesting
- Tape code	ISO / EIA Automatic discrimination
- Work coordinate system	G54 - G59
- Additional work coordinate system(48 Pair)	G54.1 P1 - 48 pairs
- Coordinate system rotation	G68, G69
- Extended part program editing	
- Optional angle chamfering / corner R	
- Macro executor	

OTHERS FUNCTIONS (Operation, Setting & Display, etc)

- Alarm display	
- Alarm history display	
- Clock function	
- Cycle start / Feed hold	
- Display of PMC alarm message	Message display when PMC alarm occurred
- Dry run	
- Ethernet function(Embedded)	
- Graphic display	Tool path drawing
- Help function	
- Loadmeter display	
- MDI / DISPLAY unit	10.4" Color TFT LCD, Keyboard for data input, soft-keys
- Memory card interface	
- Operation functions	Tape / Memory / MDI / Manual
- Operation history display	
- Program restart	
- Run hour and part number display	
- Search function	Sequence NO. / Program NO.
- Self - diagnostic function	
- Servo setting screen	
- Single block	
- External data input	
- Multi language display	

OPTIONAL SPECIFICATIONS

- 3-dimensional coordinate conversion	
- 3-dimensional tool compensation	10.4" Color LCD
- 3rd / 4th reference return	
- Addition of tool pairs for tool life management	1024 pairs
- Additional controlled axes	max. 6 axes in total
- Additional work coordinate system	G54.1 P1 - 300 (300 pairs)
- DSQ 2	200 block preview (AICC II + Machine condition selection function + Data server + 1GB)
- DSQ 3	600 block preview (AICC II with High speed processing + Machine condition selection function + Data server + 1GB)
- Automatic corner override	G62
- Chopping function	G81.1
- Cylindrical interpolation	G07.1
- Dynamic graphic displayMachining profile drawing	
- Exponential interpolation	
- Interpolation type pitch error compensation	
- EZ Guide i (Doosan infracore Conversational Programming Solution)	with 10.4" Color TFT LCD
- Increment system 1/10	
- Figure copying	G72.1, G72.2
- High speed skip function	
- Involute interpolation	G02.2, G03.2
- Machining time stamp function	
- No. of Registered programs	1000 ea
- Number of tool offsets	99 / 200 / 400 / 499 / 999 / 2000 ea
- Optional block skip addition	9 blocks
- Part program storage	1280 / 2560 m
- Playback function	
- Polar coordinate command	G15 / G16
- Polar coordinate interpolation	G12.1 / G13.1
- Programmable mirror image	G50.1 / G51.1
- Single direction positioning	G60
- Stored stroke check 2 / 3	
- Tool load monitoring function (doosan)	
- Tool position offset	G45 - G48
- Position switch	



Doosan Machine Tools

<http://www.doosanmachinetools.com>

www.facebook.com/doosanmachinetools

Optimal Solutions for the Future

Head Office

Yeonkang Bldg., 6th FL., 270, Yeonji-dong,
Jongno-gu, Seoul, Korea
Tel +82-2-3670-5345 / 5362
Fax +82-2-3670-5382

Doosan Machine Tools America

19A Chapin Rd., Pine Brook, NJ 07058, U.S.A.
Tel +1-973-618-2500
Fax +1-973-618-2501

Doosan Machine Tools China

Room 101,201,301, Building 39 Xinzhuang Highway
No.258 Songjiang District, China Shanghai(201612)
Tel +86 21-5445-1155
Fax +86 21-6405-1472

Doosan Machine Tools Europe

Emdener Strasse 24, D-41540 Dormagen, Germany
Tel +49-2133-5067-100
Fax +49-2133-5067-111

Doosan Machine Tools Japan

#2412, Mita Kokusai Bldg. 1-4-28 Mita,
Minato-ku, Tokyo 108-0073, Japan
Tel +81 3 5730 9013
Fax +81 3 5730 9016

Doosan Machine Tools India

106 / 10-11-12, Amruthahalli, Byatarayanapura,
Bellary road, Bangalore-560 092, India
Tel +91-80-4266-0122 / 121 / 100



* For more details, please contact Doosan Machine Tools.

* The specifications and information above-mentioned may be changed without prior notice.

* Doosan Machine Tools Co., Ltd. is a subsidiary of MBK Partners. The trademark  **DOOSAN** is used under a licensing agreement with Doosan Corporation, the registered trademark holder.